CHAPTER 2: GETTING TO KNOW YOUR GRiDCASE 1535 EXP COMPUTER

This chapter introduces you to your GRiDCASE 1535 EXP computer, giving a detailed description of the top, front, side, rear, and bottom views of the computer.

THE TOP VIEW

The top view of the computer is shown in Figure 2-1. Note that the GRiD logo is on the top of the case, toward the rear, and the screen latches are on the sides, toward the front.

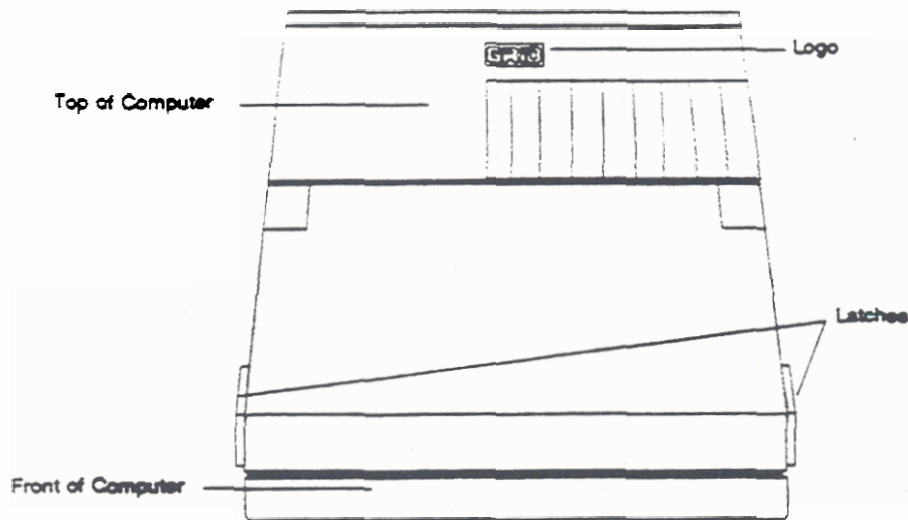

Figure 2-1. Top View of the GRiDCASE 1535 EXP Computer

THE FRONT VIEW

The front view of a GRiDCASE 1535 EXP computer is shown in Figure 2-2.

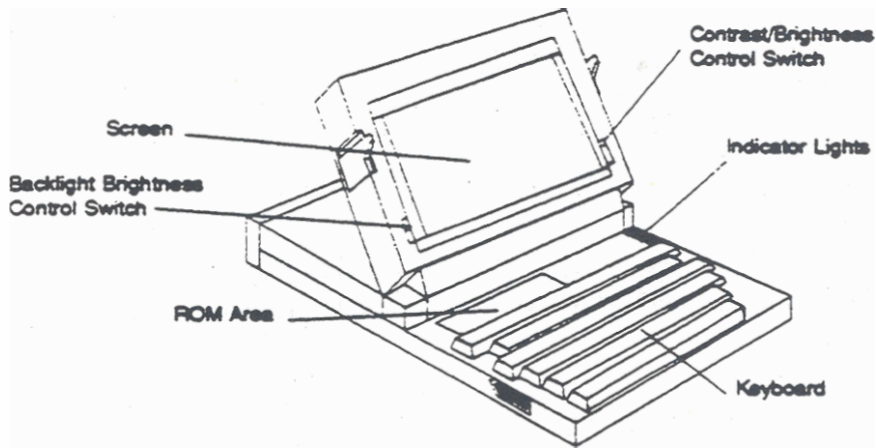

Figure 2-2. Front View of the GRiDCASE 1535 EXP Computer

Screen

The GRiDCASE 1535 EXP computer is equipped with a standard LCD screen. It has a resolution of 640 by 400 pixels, an aspect ratio of 1:1, and a contrast ratio of 11:1. An optional plasma screen is also available (see Chapter 3 for more details).

NOTE: If your computer is equipped with a plasma screen, you cannot use the AC power pack internally.

The screen is used to display your data. You should treat it with care. For complete instructions on cleaning the screen, see the section **CLEANING YOUR GRiDCASE 1535 EXP COMPUTER** in Chapter 9. For instructions on changing the color mapping mode, see the section **Changing the Color Map** later in this chapter.

You can also connect an external color monitor to your computer, as described in the Video Output Connector section at the end of this chapter.

The GRiDCASE 1535 EXP screen has a resolution of 640 by 400 pixels and supports the CGA (Color Graphics Adapter) display standard. However, many software applications are able to take advantage of the high-resolution screen if they are installed with the proper screen driver. If your application includes an option to install it for an AT&T 6300 Monochrome (640x400) display, choose that option. The GRiDCASE 1535 EXP screen is compatible with the AT&T 6300 monochrome display standard. If this option is not available or does not work properly, try installing the application for a Compaq 640x400 display. If neither of these screen driver choices operates properly, contact the GRiD Resource Center for information about custom high-resolution screen drivers that GRiD may have available for your particular application (for example, Windows/386 and AutoCAD).

Contrast/Brightness Control Switch

The contrast/brightness control switch, at the right of the screen, controls the brightness of the optional plasma screen or the contrast of the standard LCD screen. This switch increases the contrast or brightness of the screen when pushed toward the top of the screen, and decreases the contrast or brightness when pushed toward the bottom of the screen.

NOTE: If you have a plasma screen, the brightness of the screen affects power consumption—the brighter the screen, the greater the power consumption. Increasing the brightness of an LCD screen's back light also increases power consumption. Therefore, it is a good idea to decrease the brightness to conserve power when using a battery pack.

Backlight Brightness Control Switch

GRiDCASE 1535 EXP computers equipped with the standard LCD screen also have a slide switch controlling the brightness of the screen's backlight. Push this switch all the way to the bottom position to turn the backlight off; push the switch all the way to the top position for maximum brightness.

Indicator Lights

The indicator lights above the keyboard near the right side of the computer are defined as follows:

- **Upper Disk in Use:** Not used on the GRiDCASE 1535 EXP.
- **Lower/External Disk in Use:** In-use light for the internal hard disk and an external disk drive, if attached. When this indicator is green, file access is taking place on the internal hard disk. When this indicator is red, file access is taking place on an external drive. (If both drives are being accessed, the light appears orange.) Do not turn off or move the computer or remove a diskette while this light is lit.
- **Processor Speed Low:** Processor speed indicator. The GRiDCASE 1535 EXP is equipped with a dual-speed microprocessor. The computer ordinarily runs at 12.5 MHz; however, it can be slowed to 6.25 MHz. There is generally no reason to do this except in rare cases when a piece of software cannot run at the faster speed. When you switch to the slower clock speed, the processor speed indicator lights to remind you that the computer is running at the slower speed. **Running the processor at low speed is NOT recommended when the expansion tray is attached to the computer; some expansion cards may not be able to operate correctly when the computer is running at low speed.**
- **Battery Charging/Battery Low:** When a battery pack is charging inside the computer, this indicator turns green. When the computer is being powered by an internal battery pack, and the battery pack's charge becomes very low, this indicator turns red. This indicates that you have about 5 minutes of operation left. You should save any files you are working on and then either supply AC power or turn the computer off and change battery packs.

If you have a low battery in the power pack/accessory slot, and you connect the AC power pack externally, the AC power pack begins to recharge the battery pack. While the battery pack's charge remains low, the indicator appears orange (actually a combination of red, to indicate a low battery, and green, to indicate charging is taking place). When the battery pack's charge is no longer low, the indicator turns green; however, the battery pack is still being charged.

NOTE: If you have attached the expansion tray to your computer, you cannot power the computer with an internal battery pack, although you can charge the battery pack internally.

ROM Area

The ROM area contains mounting positions for ROMs. A ROM is a storage device for programs. Each ROM can hold up to 256 KB (about 262,000 characters). You can install up to two ROMs, giving you 512 KB of additional storage space. Refer to the *Read Only Memory (ROM) Installation and Use* guide that came in your ROM package for information on installing ROMs.

CAUTION

Always turn off the power before attempting to install or remove ROMs.

Keyboard

Figure 2-3 shows the GRIDCASE 1535 EXP keyboard. The keyboard provides you with all the functionality of the IBM PC/AT keyboard. The keys marked in green and blue provide the additional functions found on the IBM keyboard.

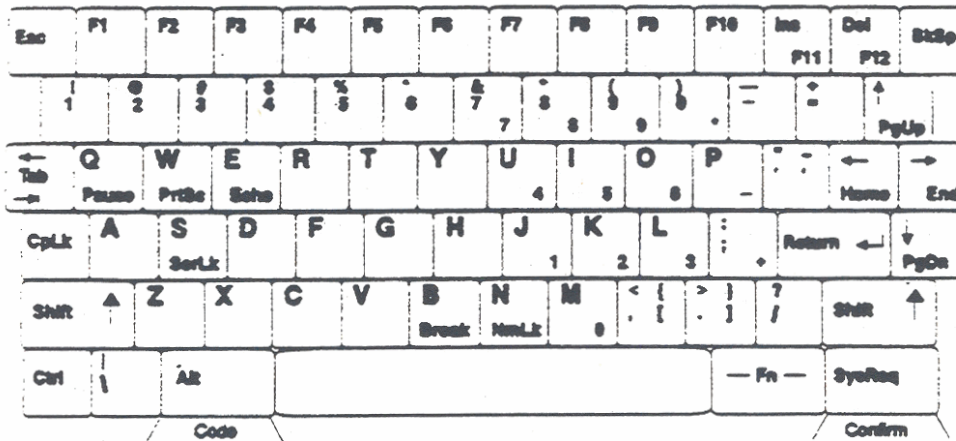

Figure 2-3. GRIDCASE 1535 EXP Keyboard

To use the F11 IBM PC function key, hold down the Fn key (in the lower right-hand corner of the keyboard) and press the F11 key. To use the F12 function key, hold down the Fn key and press the F12 key. To use function keys F13 through F20, hold down the Shift key and press one of the keys F3 through F10, where F3 corresponds to F13, and so on.

Using the Numeric Keypad

To conserve space, the GRIDCASE 1535 EXP keyboard overlays the numeric keypad keys on the regular alpha-numeric keyboard (refer to Figure 2-3.)¹

To use the numeric keypad keys, you must first put the computer in NumLock mode. To do so, press the **Fn** and **NmLk** keys simultaneously.

While the computer is in NumLock mode, the numeric keypad keys return numeric values only; you cannot use the key's alphabetic values. To return the keys to their standard alpha-numeric values, press the **Fn-NmLk** combination again.

You can also access the numeric keypad keys when the computer is not in the NumLock mode. To do so, press the **Fn** key and the desired keypad key simultaneously.

Table 2-1 lists IBM PC/AT special keys and their GRIDCASE 1535 EXP equivalents.

¹ Note that the cursor-movement keys found on the IBM numeric keypad are separate keys on the GRIDCASE keyboard.

Table 2-1. IBM PC/AT Special Keys and GRIDCASE 1535 EXP Equivalents

| Function Keys | | |
|---------------|-----------|-----------------------|
| Function Key | IBM Key | GRIDCASE 1535 EXP Key |
| F1 | F1 | F1 |
| F2 | F2 | F2 |
| F3 | F3 | F3 |
| F4 | F4 | F4 |
| F5 | F5 | F5 |
| F6 | F6 | F6 |
| F7 | F7 | F7 |
| F8 | F8 | F8 |
| F9 | F9 | F9 |
| F10 | F10 | F10 |
| F11 | Shift-F1 | Fn-F11 |
| F12 | Shift-F2 | Fn-F12 |
| F13 | Shift-F3 | Shift-F3 |
| F14 | Shift-F4 | Shift-F4 |
| F15 | Shift-F5 | Shift-F5 |
| F16 | Shift-F6 | Shift-F6 |
| F17 | Shift-F7 | Shift-F7 |
| F18 | Shift-F8 | Shift-F8 |
| F19 | Shift-F9 | Shift-F9 |
| F20 | Shift-F10 | Shift-F10 |

| Cursor-Control Keys | |
|---------------------|-----------------------|
| IBM Key | GRIDCASE 1535 EXP Key |
| RightArrow | RightArrow |
| LeftArrow | LeftArrow |
| DownArrow | DownArrow |
| UpArrow | UpArrow |
| End | Fn-End |
| Home | Fn-Home |
| PgDn | Fn-PgDn |
| PgUp | Fn-PgUp |

Table 2-1 (continued)

Typewriter Keyboard Keys

| IBM Key | GRIDCASE 1535 EXP Key |
|---------------------|------------------------------|
| Alt | Alt |
| Backspace | BkSp |
| Break | Fn-Break |
| Caps Lock | CpLk |
| Ctrl | Ctrl |
| Ctrl-C | Ctrl-C |
| Ctrl-PrtSc (Ctrl-P) | Fn-W |
| Ctrl-S | Ctrl-S |
| Echo | Fn-Echo |
| Enter | Return |
| Esc | Esc |
| Pause | Fn-Pause |
| Shift-PrtSc | Fn-PrtSc |
| Right Shift | Right Shift |
| Left Shift | Left Shift |
| Tab | Tab |
| Shift-Tab | Shift-Tab |

Special Characters

| IBM Key | GRIDCASE 1535 EXP Key |
|----------------|------------------------------|
| [| Fn-[|
|] | Fn-] |
| { | Fn-Shift-{ |
| } | Fn-Shift-} |
| ~ | Fn-Shift-~ |
| ' | Fn-' |

Table 2-1 (continued)

Numeric Keypad Keys

| IBM Key | GRIDCASE 1535 EXP Key |
|-------------|-----------------------|
| Del | Del |
| Ins | Ins |
| Num Lock | Fn-NmLk (N) |
| Gray + | numeric keypad + (I) |
| Gray - | numeric keypad - (P) |
| Gray * | numeric keypad * (O) |
| 1 | numeric keypad 1 (J) |
| 2 | numeric keypad 2 (K) |
| 3 | numeric keypad 3 (L) |
| 4 | numeric keypad 4 (U) |
| 5 | numeric keypad 5 (I) |
| 6 | numeric keypad 6 (O) |
| 7 | numeric keypad 7 (7) |
| 8 | numeric keypad 8 (8) |
| 9 | numeric keypad 9 (9) |
| 0 | numeric keypad 0 (M) |
| Scroll Lock | Fn-ScrLk (S) |

Consult the *MS-DOS Reference* manual to learn how the keys function on a GRIDCASE 1535 EXP computer.

Changing the Color Map

The built-in LCD screen is a monochrome screen; it does not display colors. However, it is compatible with all software that uses the CGA (color graphics adapter) standard. Colors displayed by software are changed to various shades of blue on the LCD screen. This is called color mapping. Some software looks better in one mode than in another. The GRIDCASE 1535 EXP supports six different color mapping modes.

The key combinations shown below change the current color mapping mode. The default is mode 1.



    increments the color mapping mode to the next higher numbered mode

    decrements the color mapping mode to the next lower numbered mode

You can also use the MODE command to set the color mapping mode—see the section on the MODE command in Chapter 10 for details on color mapping.

Changing the Video Output

Pressing the following three keys simultaneously toggles video output between the built-in display and an external monitor attached to the video output connector:

Changing the Processor Speed

The key combinations shown below switch between high and low processor speeds.

You can also use the MODE command to change the processor speed—see the section on the MODE command in Chapter 10 for details on changing the processor speed.

    sets the processor to low speed (6.25 MHz)

    sets the processor to high speed (12.5 MHz)

THE SIDE VIEW

Figures 2-4 and 2-5 show side views of the GRIDCASE 1535 EXP computer in various configurations.

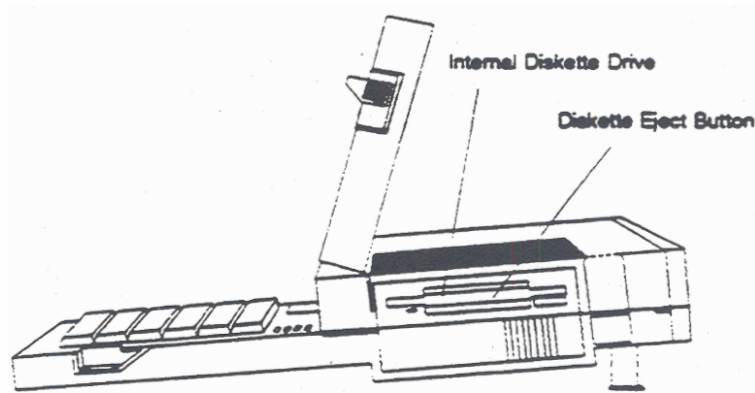

Figure 2-4. Side View of the GRIDCASE 1535 EXP Computer Equipped with a Standard 3½-Inch Floppy Diskette Drive

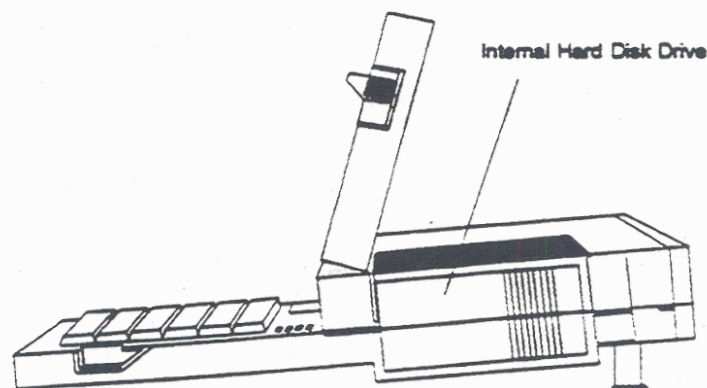

Figure 2-5. Side View of the GRIDCASE 1535 EXP Computer Equipped with an Optional Hard Disk Drive

Internal Diskette Drive

The internal diskette drive uses 3½-inch double-sided, high-density floppy diskettes capable of storing 1.4 MB of data each. This drive can also read, write, and format double-density 720 KB (kilobyte) diskettes. Chapter 1 contains a brief description of how to insert diskettes in the drive. For more detailed information about the drive and about floppy diskettes, refer to Chapter 5.

Diskette Eject Button

The diskette eject button, below and to the right of the diskette slot, is used to eject the floppy diskette currently in the diskette drive. To remove a diskette, push in the diskette eject button until the floppy diskette pops out.

Internal Hard Disk Drive (Optional)

GRIDCASE 1535 EXP computers can be equipped with an optional internal hard disk. The hard disk is factory formatted and comes with the MS-DOS operating system files already loaded. For more information about the internal hard disk, see Chapter 5.

THE REAR VIEW

The rear view of a GRIDCASE 1535 EXP is shown in Figure 2-6. You will use many of the items shown here when setting up your computer. Each item is explained on the following pages. To help you with setting up, a label containing all the connector names appears on the handle.

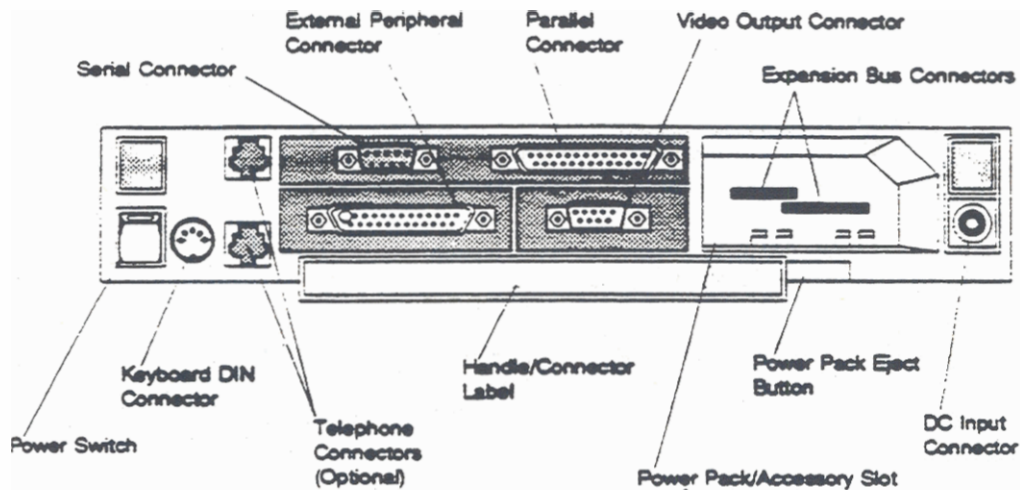

Figure 2-6. Rear View of the GRIDCASE 1535 EXP Computer

Power Switch

The power switch, on the far left, turns the computer on and off. To turn on the computer, press the top of the switch. To turn it off, press the bottom of the switch. You can also use this switch to restart the computer. See the section WARM START-UP in Chapter 1 for details.

CAUTION

Never turn off the computer when the disk in-use light for the internal drive or any other storage device is on. The disk in-use light means that file access may be taking place; turning off the computer at this time can destroy data.

Shielded Cables

The GRiDCASE 1535 EXP computer has been tested for electromagnetic interference potential using shielded I/O cables. If you purchase or replace I/O cables, they should be shielded cables to minimize interference to radio, television, and other communication services. Telephone cables do not require shielding.

Keyboard DIN Connector

The keyboard DIN connector connects the GRiDCASE EXP to an external IBM PC/AT-compatible keyboard or a keypad.

NOTE: IBM PC/XT-compatible keyboards cannot be connected to the GRiDCASE 1535 EXP.

Connecting a Keyboard or Keypad to the DIN Connector

You can connect an IBM PC/AT keyboard, any other 100% compatible keyboard, or a GRiD-supplied keypad to your GRiDCASE 1535 EXP computer by following the steps listed below.

1. Turn off the computer and any other peripherals.

CAUTION

Before connecting or disconnecting a keyboard, keypad or any other external device, turn off the power to both the computer and (if applicable) the external device. Failure to do so may damage your unit.

2. Plug the keyboard or keypad cord into the keyboard DIN connector on the back of the computer. The cord fits into the connector in only one way. Be sure to correctly match up the end of the cord with the connector pins.
3. Turn on the computer and any peripherals.

You can now use either the external keyboard, the keypad, or the GRiDCASE keyboard.

Telephone Connectors (Optional)

The telephone connectors let you access the optional internal modem. The connectors are standard modular jacks. One jack is for the cord that ordinarily plugs into the back of your telephone. The other jack is for an optional cord to connect your telephone to the computer. That is, one jack connects the modem to the phone system, and the other connects the modem to your telephone. If you use both jacks, you can switch back and forth between modem and telephone use without moving the cord from the modem to the telephone and vice versa. You cannot, however, use the modem and the telephone at the same time. It does not matter which connector you use for which cord. For more information on using the internal modem, see Chapter 3 and the *Internal Modem User's Guide*.

Serial Connector

The serial connector allows you to connect your computer to external modems, serial printers, and other serial devices. Only one peripheral at a time can be connected to the computer through the serial connector. This connector is a 9-pin RS-232C connector.

You can use the MS-DOS MODE command to change the serial port's default settings. For instructions on using the MODE command, refer to Chapter 10.

Connecting an External Modem to the Serial Connector

You can connect any external modem that is compatible with the software you are using (with a Model 6400 serial cable or equivalent) to the serial connector on the rear panel of the computer. Consult the manual that accompanies the software for the correct switch settings for your modem.

After the switches are set, you are ready to connect your modem to the computer. Follow the steps listed below.

1. Turn off the computer, modem, and any other peripherals.

CAUTION

Before connecting or disconnecting a modem or any other external device, turn off the power to both the computer and the external device. Failure to do so may damage your unit.

2. Attach the Model 6400 serial cable to the serial connector on the back of your modem.
3. Attach the other end of the cable to the serial connector on the back of the computer.
4. Plug in the power cord from the modem into a wall outlet.
5. Turn on the modem (and any other peripherals), and then turn on the computer.

Connecting a Printer to the Serial Connector

You can connect a serial printer (using a Model 6400 serial cable or equivalent) to the serial connector on the rear panel of the computer.

Before using a printer for the first time with a particular software program, you must make sure that the software is properly configured for your printer (refer to the documentation for the software program and the printer for configuration details). Generally, software configuration consists of installing the appropriate printer driver software for your printer. A printer driver is a program that allows the computer to communicate with a particular make and model of printer. Most application programs include printer drivers for a variety of different printers.

Before connecting the printer, make sure that the configuration switches on the printer are set properly. These switches determine how the printer operates.

After the switches are set correctly and the appropriate printer driver is installed, you are ready to connect the printer to the computer. To connect a serial printer to the computer, follow the steps listed below.

1. Turn off the computer, the printer, and any other peripherals.

CAUTION

Before connecting or disconnecting a printer or any other external device, turn off the power to both the computer and the external device. Failure to do so may damage your unit.

2. Attach the serial cable to the serial connector on the back of the computer.
3. Attach the other end of the serial cable to the serial connector on the back of the printer.
4. Check your printer manual for instructions on loading the ribbon, paper, and other supplies into the printer.
5. Position your paper so that the print head is at the top of the page.
6. Make sure all power cords are plugged in.
7. Turn on the printer (and any other peripherals), and then turn on the computer.

Parallel Connector

The parallel connector connects the computer to printers and other parallel devices using a Model 6220 parallel printer cable. Note the trapezoidal or "D" shape; it makes an improper connection impossible. Only one peripheral at a time can be connected to the computer through the parallel connector.

NOTE: The parallel connector is physically similar to the external peripheral connector. Do not connect a GRID external drive to the parallel connector. A drive connected in this way will not work.

Connecting a Printer to the Parallel Connector

Read the previous section, Connecting a Printer to the Serial Connector. You must follow the same prerequisites before connecting a printer to the parallel connector. To connect a parallel printer to the computer, follow the steps listed below.

1. Turn off the computer, the printer, and any other peripherals.

CAUTION

Before connecting or disconnecting a printer or any other external device, turn off the power to both the computer and the external device. Failure to do so may damage your unit.

2. Attach the parallel printer cable to the parallel connector on the back of the computer.
3. Attach the other end of the parallel printer cable to the parallel connector on the back of the printer.
4. Check your printer manual for instructions on loading the ribbon, paper, and other supplies into the printer.
5. Position your paper so that the print head is at the top of the page.
6. Make sure all power cords are plugged in.
7. Turn on the printer (and any other peripherals), and then turn on the computer.

External Peripheral Connector

You can connect one of the following external devices to the external peripheral connector on your GRiDCASE 1535 EXP computer:

- Model 3401 3½-inch High Density Pocket Diskette Drive (1.4 MB)
- Model 3402 5¼-inch Pouch Diskette Drive (360 KB)
- Model 3404 5¼-inch High Density Pouch Diskette Drive (1.2 MB)
- Model 3403 40 MB Backup Tape System

NOTE: The 3½-inch pocket diskette drive receives its power through the external peripheral connector. The 5¼-inch pouch diskette drives and the tape drive receive their power from their own AC power packs.

Though this port looks like the parallel port, it supports only GRiD external diskette and tape drives. You cannot plug the cable for any other device into this connector—one of the pin holes not used by the drive cable connector is blocked to prevent an improper connection. Do not attempt to force any cable onto this connector. For more information on connecting an external drive, see Chapter 6.

Video Output Connector

The video output connector connects your GRiDCASE 1535 EXP computer to a color monitor or video projector.

Connecting a Color Monitor to the Video Output Connector

You can connect any IBM PC color monitor to your GRiDCASE 1535 EXP computer, provided it is compatible with the IBM Color Graphics Adapter (CGA) standard. To connect the color monitor to the computer, follow the steps listed below.

1. Turn off the computer, the monitor, and any attached devices.

CAUTION

Before connecting or disconnecting a color monitor or any external device, turn off the power to both the computer and the external device. Failure to do so may damage your unit.

2. Attach the cable from the monitor to the video output connector on the back of the computer.
3. Plug the power cord from the monitor into a properly grounded outlet.
4. Turn on the monitor (and any other peripherals), and then turn on the computer.

Note that you cannot display data simultaneously on the built-in screen and on an external monitor. To switch back and forth between internal and external displays, press the **Ctrl, Alt, and Tab** keys simultaneously.

Connecting a Video Projector to the Video Output Connector

You can connect the following color and monochrome video projectors to your GRIDCASE 1535 EXP computer:

- Sony Model VPH-1020Q or Electrohome ECP1000 Color Video Projector. This requires the Electrohome 38-800307-61 PC color interface, which outputs a separate signal for red, green, blue, and external synchronization via coaxial connectors.
- Electrohome EDP-58 Monochrome Video Projector. This requires the Electrohome 38-800003-60 Model IM-56 monochrome interface and Model 800-037 wiring harness, which outputs a monochrome signal.
- Vivid Systems Vivid LimeLight Computer Projector Model LLCP. This requires the Vivid Systems Model VARGB IBM PC/XT Color Adapter, which outputs a monochrome signal with shading.

See your local Electrohome or Vivid Systems dealer for assistance in connecting these projectors.

Power Pack/Accessory Slot

The internal/external AC power pack or battery pack fits into the power pack/accessory slot. See Chapter 4 for a description of these items and how to use them.

This slot also contains expansion bus connectors that allow you to add GRIDCASE 1500 Series™ expansion products to your GRIDCASE 1535 EXP computer.

CAUTION

Expansion cartridges can only operate properly with the expansion tray detached from the computer.

The expansion bus connectors are accessible only when you power the computer externally.

NOTE: These expansion bus connectors are in addition to the expansion bus connector provided on the bottom of the computer (see Figure 2-7).

Power Pack Eject Button

The power pack eject button, immediately below the power pack/accessory slot, ejects the battery pack or the internal/external AC power pack. (Expansion products are equipped with their own pull knobs for easy ejection from the power pack/accessory slot.)

CAUTION

Always save your work and turn the computer off before ejecting the battery pack from the power pack/accessory slot; any data in RAM (main memory) is lost if there is no other source of power to the computer.

Also, never remove the battery pack when the in-use light for the internal drive or any other storage device is lit. The in-use light means that file access may be taking place; removing power at this time can destroy data.

DC Input Connector

The DC input connector connects the computer to an internal/external AC power pack as described in Chapter 4.

THE BOTTOM VIEW

The bottom view of the GRiDCASE 1535 EXP computer is shown in Figure 2-7, below.

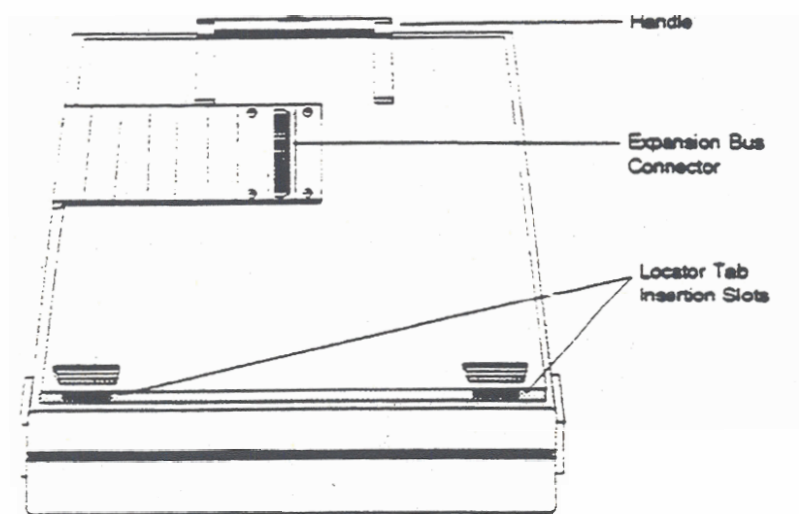

Figure 2-7. Bottom View of the GRiDCASE 1535 EXP Computer

Expansion Bus Connector

The expansion bus connector on the underside of the GRiDCASE 1535 EXP computer connects the computer to an expansion tray. For information on attaching an expansion tray to the computer, refer to Chapter 7.

CHAPTER 3: BUILT-IN OPTIONS

This chapter describes the built-in options available from GRiD Systems Corporation to enhance the performance of your GRiDCASE 1535 EXP computer.

THE OPTIONS

The built-in options are listed in Table 3-1.

Table 3-1. Built-in Options Available for the GRiDCASE 1535 EXP Computer

| Option/Model Number | Description |
|-------------------------------|--|
| Display: | |
| Plasma Display Option 282 | This display replaces the standard backlit LCD and provides a 640-pixel by 400-pixel light-emitting gas plasma display. Measures 10" diagonally. |
| System RAM: | |
| 2 MB System RAM Option 302 | 2 MB of main memory in place of the standard 1 MB. |
| 4 MB System RAM Option 304 | 4 MB of main memory in place of the standard 1 MB. |
| 8 MB System RAM Option 308 | 8 MB of main memory in place of the standard 1 MB. |

| | |
|---|---|
| Mass Storage: 40 MB Hard Disk Option 354 | 40 MB hard disk drive replaces the standard floppy diskette drive. |
| 100 MB Hard Disk Option 355 | 100 MB hard disk drive replaces the standard floppy diskette drive. |
| MS-DOS ROM Option 372 | Version 3.3 of the MS-DOS operating system stored in a single 128 KB Read Only Memory (ROM) chip. The operating system is always available, but requires no disk storage. |
| Modems: 2400 Baud Option 331 | Built-in Hayes-compatible modem allows data transmission up to 2400 baud. |
| MNP 2400 Baud Option 332 | Built-in Hayes-compatible modem with MNP error detection, correction, and data compression allows data transmission up to 2400 baud. |
| Coprocessor: 80387 Numeric Coprocessor Option 341 | Provides faster operation for math-intensive applications (for example, spread sheets, vector graphics, etc.). |

DISPLAY

A gas plasma display is available in place of the standard backlit LCD screen. Gas plasma displays, unlike LCDs, are light emitting and may therefore be more appropriate when ambient lighting conditions are poor or variable.

The gas plasma display measures 10 inches diagonally. Its resolution is 640 by 400 pixels, and its aspect ratio is 1:1. The display has a contrast ratio of 20:1. For information on how to take full advantage of the high-resolution 640 by 400 display, see the section Screen in Chapter 2.

SYSTEM RAM

GRiDCASE 1535 EXP computers are available in 1 MB (standard), 2 MB, 4 MB, and 8 MB system RAM configurations. RAM above 640 KB is user configurable as any combination of EMS (Lous/Intel/Microsoft standard) memory and IBM PC/AT-compatible extended memory; additionally, some of the extra memory can be used to extend standard MS-DOS memory from 640 KB up to 736 KB. Refer to the *GRiD386 User's Guide* for RAM configuration information.

MASS STORAGE

The internal hard disk options provide either 40 MB or 100 MB of permanent storage. Both hard disks come formatted for use with MS-DOS.

ROMS

Read Only Memory (ROM) chips are a permanent storage device for programs. By using programs in ROM, you no longer need to carry these programs on floppy diskettes or any other storage device. ROMs are also the most rugged storage medium available.

You can install ROMs in the ROM mounting positions located just above the keyboard (see Figure 2-2). You can install either one or two ROMs, giving you up to 512 KB of additional space for programs. For information on installing and removing ROMs, see the *Read Only Memory (ROM) Installation and Use* guide that accompanies your ROM package.

CAUTION

Always turn off the power before attempting to install or remove ROMs.

NUMERIC COPROCESSOR

An 80387 numeric coprocessor is available for the GRiDCASE 1535 EXP.

The coprocessor is designed for faster display of graphics and calculation of worksheets and other kinds of files.

Check your application documentation to see if an 80387 coprocessor is required or recommended.

MODEM

An internal modem is available for GRiDCASE 1535 EXP computers. The internal modem transmits and receives data through the telephone system. Because the internal modem resides inside the computer, it provides greater convenience than an external modem when you are traveling or moving your equipment. The internal modem operates through most standard telephone systems in the U.S.A. or Canada. The 2400 baud modem (Option 331) and the MNP 2400 baud modem (Option 332) can both transmit and receive data at 300, 1200, or 2400 baud. The MNP modem also provides MNP (Microcom Networking Protocol) level 5 error detection, correction, and data compression. See the *Internal Modem User's Guide* for more information on these modem options.

Connecting the Telephone Line

Assuming your telephone uses a standard, plug-in modular jack, your phone cord plugs directly into the telephone connector on the back of the computer. Most offices and residences now use the standard plug-in jack connector. If you have a different kind of telephone connector, see the section Alternative Telephone Connections below.

To connect a GRiDCASE 1535 EXP computer to the telephone system, unplug the cord from the back of your telephone and plug it into one of the telephone connectors on the back of the computer (see Figure 3-1).

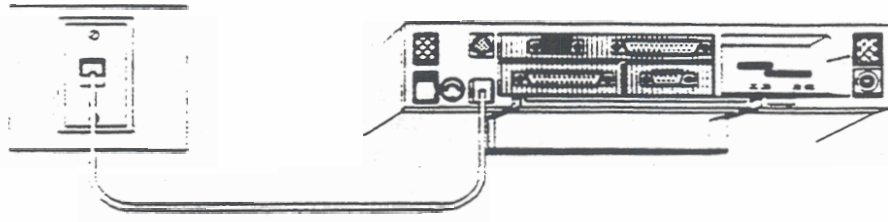

Figure 3-1. GRiDCASE 1535 EXP Computer Connected to Phone Jack

To use your telephone while your computer is connected to the same phone line, you will need another telephone cord. Connect the computer to the phone jack and then use the second telephone cord to connect the telephone to the other connector, as shown in Figure 3-2.

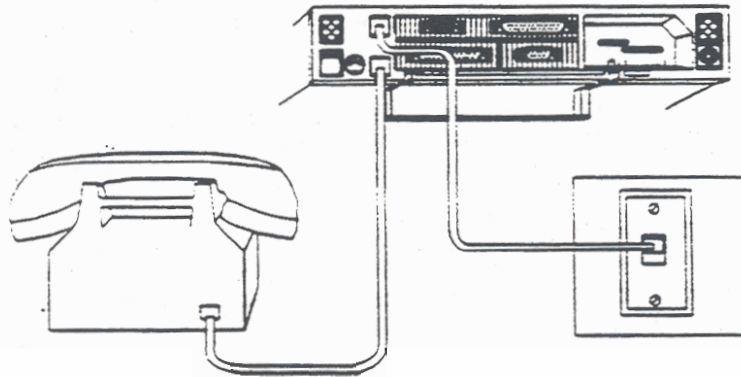

Figure 3-2. Modem Connected to Telephone System and Phone

With the appropriate software, you can now use the same telephone line either to speak on the phone or to transmit and receive data from another computer. (You cannot talk and send data at the same time.)

NOTE: When connecting to a remote computer, the modem speaker is turned off immediately after the connection is made.

If your internal modem is not working properly, see Appendix A to determine if it is your modem or the telephone line that is causing the problem.

NOTE: The computer modem will not function with digital PBX telephone systems that use digital telephone sets. If you are unsure whether your internal modem will work with your PBX telephone system, contact your local GRiD representative.

Alternative Telephone Connections

Some telephone systems do not use the modular plug-in jack connector. Some use different types of connectors, and others are permanently wired. Read this section if you find that there is no modular connector available to plug into your computer's telephone connector.

Some older telephone systems use four-prong connectors. These require an adapter available from most electronics stores. (One such adapter is the Radio Shack Model 279-351.)

Some offices use large Amphenol connectors for phones that have several lines coming in. Many adapters are available to tap into these connectors. (Radio Shack Models 43-271 and 43-270 are two commonly available adapters.)

In situations where the telephones are permanently wired, the simplest solution is to use a special coupler that attaches to the handset of the telephone and provides a modular connector for plugging into your computer. The following couplers are available at many electronics dealers or computer stores. (These couplers may not function in all situations.)

- The Konexx Modem Connection Adapter (GRiD Model 34022), which allows direct electronic connection to telephones not equipped with modular connectors. This adapter plugs into the handset jack on the phone base and supports both voice and data modes, all baud rates, and several different types of phones.
- The GRiD Acoustic Modem Adapter (GRiD Model 32180), which attaches to almost any size and shape handset. This adapter supports 300 baud communications and, in some cases, can be used in 1200 baud communications.

- The Black Jack (from the Microperipheral Corporation), which attaches to telephone handsets with round mouthpieces that can be unscrewed.

There are also many models of acoustic couplers available with built-in modems. These attach to the serial connector of the computer. Most can transmit at 300 baud, and some can transmit at 1200 baud. These are available at many computer stores.

Using the Modem

Your MS-DOS application program may require you to change the modem switch settings. Because the modem is internal, there are no physical switches to set; however, the Hayes Smartmodem switch settings are emulated in software. If your application requires settings different from these, you can use the MODE command to change them. For details on using the MODE command to change the switch settings or the baud rate, refer to Chapter 10.

The MNP modem must be communicating with another MNP modem to take advantage of the MNP features. In order for your application to use the MNP modem, MNP must be enabled in the application, if the feature is available.

Refer to the *Internal Modem User's Guide* for more information on using the modem and the modem command set.